



An Intelligent PV Panel Structure to Extract the Maximum Power in Mismatch Irradiance

A. Esmaeli*

Plasma and Nuclear Fusion School, Nuclear Science and Technology Research Institute, Tehran, Iran

PAPER INFO

Paper history:

Received 17 May 2014

Accepted in revised form 11 November 2014

Keywords:

 Photovoltaic
Maximum Power Point Tracking
Tracking Algorithm
Intelligent Structure

ABSTRACT

A new intelligent photovoltaic (PV) panel structure to extract the maximum power in mismatch irradiance is proposed. In conventional structures, difference of irradiance between series panels can cause the deviation of maximum power point. In this condition tracking MPP becomes difficult and reduces efficiency. Improvements in power electronics and its effects in PV industrial technology, developed many new PV structure in recent years. This paper proposes a new intelligent structure with module integrated converter for increasing energy capture in the PV series string. The advantage of new structure is that the MPP region extends from single panel MPP to a much wider range, causing the panels to operate independent of each other in mismatch condition. To study and show advantage of intelligent structure, a real simple model is selected and verified. For operating in MPP region, P&O algorithm is selected. Despite conventional structures, voltage is not appropriately varied for P&O algorithm used in intelligent structure and system experiences instability. To solve this instability problem, resistance is proposed as variable. MATLAB/Simulink is used for simulation and demonstration of expression. The results of this work have shown that using intelligent structure improves the energy harvesting up to 14 percent, and resistance is the best variable in tracking speed and accuracy.

1. INTRODUCTION

The growing nationwide interest in photovoltaic power systems has induced significant expansion and R&D efforts in the PV field. These researches are focused on the low-cost production of photovoltaic panels and optimal power transmission in conditions of radiation intensity variations [1,2]. Development of new technologies such as thin film, because of its flexibility and elimination of the support system, makes this kind of energy affordable especially for residential purposes. Advances in power electronics and its entry into the photovoltaic systems along with the development of the panels has caused the emerging of various structures of power electronics converters and photovoltaic panels leading to more development of photovoltaic industry [3,4]. In this paper, after detailed survey of the conventional structures, we have focused on the structure shown in Figure 1.

In this structure, each panel is connected to the converter, then converters are connected in series, and arranged in parallel branches [5]. The result of using

this system is lower cost and high reliability because of the independent operation of each panel in different climatic conditions compared to its adjacent panels. Converter used in the proposed structure architecture based on the reference converter consists of a buck converter cascaded by a boost stage where both converters share the inductor.

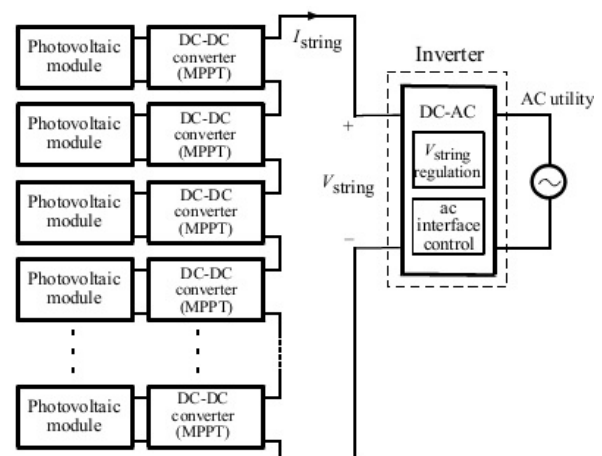

Figure 1. Block diagram of intelligent

*Corresponding Author's Email: aesmaeli@aeoi.org.ir (A. Esmaeli)

This converter operates in three modes: buck, boost, or forward [6].

The resulting system is a PV panel that operates independent of the geometry and complexity of the system around it. Each controller is completely autonomous and the module maximum power point trackers (MPPTs) are decoupled from each other, adding robustness and reliability [7,8]. By using this converter, it is possible to regulate the PV string voltage to a fixed value, giving rise to the possibility of adding more strings or batteries to the system. A constant string voltage is also beneficial, because then it becomes possible to optimize the inverter design, size and cost.

In this paper, detailed analysis of intelligent converter PV system is presented. Model of traditional PV system and intelligent converter system are constructed. The centralized system, string system and intelligent converter PV system are compared based on the model and the advantage of intelligent converter system is clearly illustrated. Further analysis of intelligent converter system renders the demonstration of its MPPT requirements and the power management issue is clearly shown. Finally, resistance is selected as MPPT control variable.

2. PV STRUCTURES

In the centralized system, multiple PV panels are connected in series as PV string to reach certain voltage level. Parallel-connected strings are then wired into a centralized PV converter interfacing PV array with a DC bus. The drawback of centralized system is that there are more than one MPPs residing on both the string and total P-V curves.

The difference between Strings structure with centralized PV system is the former the second stage converter splits into individual converters for each PV panel string. Each individual string converter does MPPT for each string leaving no interaction between different strings. However, because PV string is still comprised of multiple panels in series, MPPT performance for each string will still be not good due to direct series connection.

Although Micro Converters seem to have no problems in mismatch condition, the drawbacks are mainly cost and efficiency. Due to the fact that these Micro Converters should be high step-up ratio and converters that utilize transformers in their topologies should be applied, it generally indicates a more complex converter structure that includes more devices. Thus, the cost will be increased.

Via intelligent structure, the converter performs MPPT which continuously forces the operating point of PV panel at MPP. The output, then behaves as a constant power source which is a hyperbolic curve. Essentially, the MPPT region is extended from single panel MPP into a much wider range. Therefore, the advantage is

obvious compared to conventional centralized and string PV system. If the MPPT regions of intelligent converters connected in one string share certain current overlapping, it is then guaranteed that all the panels in this string can generate maximum power.

3. CASE STUDY

A simple, but typical case is studied in this section. Figure 2. shows Solar Panels Mounted on the roof of a residential home. The PV power system contains three ten-panel strings and thirty 170W PV panels, forming a typical 5kW system. A, B, C stands for different strings which are connected in parallel. In fact, this arrangement of PV panel is usually regarded as a good one because of its same model and the fact that it is facing the sun in the same angle and direction. However, one should notice the chimney and venting pipes will cause shading effect on adjacent panels. Figure 2. gives such an example where Panels C1, C2, C5, A8, A9, A10 are shaded at different levels. In order to quantify the analysis, approximation is made that panel peak power reduction rate is proportional to shading area; equivalent irradiance for these shaded panels can then be estimated as follows:

1-Normal panels: 1000W/m²;

2- Shaded panels:A8: 600W/m²; A9:800W/m²; A10: 850W/m²; C1:500W/m²; C2:200W/m²; C5: 700W/m².

The panel temperature is assumed 25°C. The panel temperature is assumed 25°C.

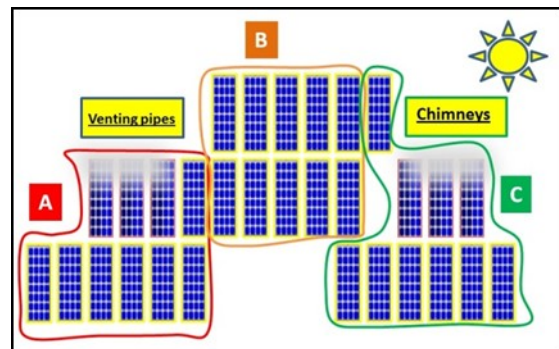

Figure 2. The panel arranged on the roof

3. 1. Central Structures At first, Centralized structure is used as we can see the panels are arranged as in Figure 3. Using the PV panel model and the assumption of different panel irradiance, all panel output characteristics can be derived and plotted. As an example, firstly the output I-V curves of all the panels in string A are plotted in Figure 4. Actually, there are four different irradiance levels in string A. Since all panels share the same string current, the string output can be derived by directly stacking all panel curves along horizontal axis, which renders the composite I-V curve as shown in Figure 5. It then clearly shows that

the total output of the string is no longer like the extension of one single panel, essentially due to the fact that the MPP currents of panels of different irradiance levels are different. Therefore, multiple power points can be found near different irradiance MPPs. The output of the panels of string A has four different kinds of curves as Plotted in Figure 5.

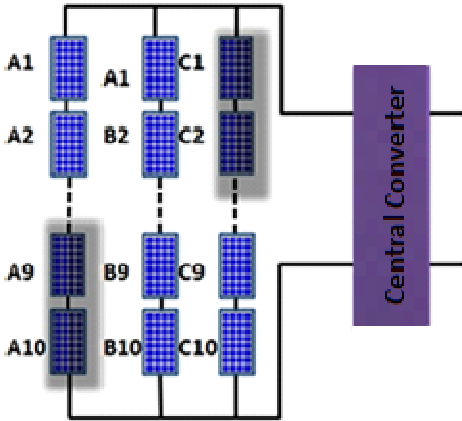

Figure 3. case study arranged with central structure (Shaded A8 and C5 missing – use of foreign language!)

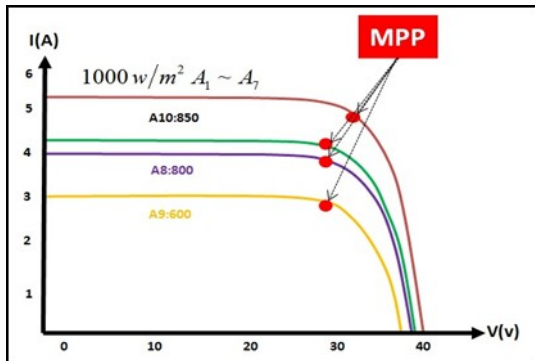

Figure 4. Current versus voltage in string A panels

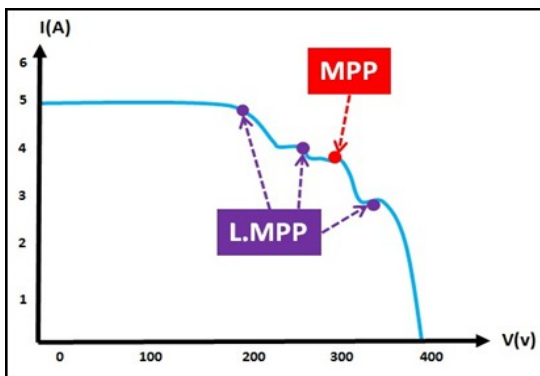

Figure 5. Output current versus voltage string A

Figure 6. shows multiple maximum power points on P-V characteristics curve of strings A, B, C and total arrays to panel mismatch. Among the three peaks (P1, P2, P3 as shown in Figure 6.), even if the MPPT successfully tracks the highest peak point P1, the system can deliver 4085W power. total available power of the system is the sum of all panels maximum Power and is 4672W. Here only 87.5% of the available power is successfully utilized. It indicates significant equivalent power loss, and thus is not desirable.

The main job of converter is to continuously track the maximum power point of the connected PV panel. Thus, the converter behaves as a constant power source when MPPT is performing. Besides, the maximum converter output voltage and current should be limited by power device rating. Therefore, output voltage and current limit are also employed. In other words, the converter works basically in three modes: MPPT mode, output voltage limit mode and output current limit mode. Figure 8. shows the three-mode I-V curve with typical voltage and current limit under the same mismatch condition. The main job of converter is to continuously track the maximum power point of the connected PV panel. Thus, the converter behaves as a constant power source when MPPT is performing. Besides, the maximum converter output voltage and current should be limited by power device rating. Therefore, output voltage and current limit are also employed. In other words, the converter works basically in three modes: MPPT mode, output voltage limit mode and output current limit mode. Figure 8. shows the three-mode I-V curve with typical voltage and current limit under the same mismatch condition.

3. 2. Intelligent structure Considering the same mismatch condition, if the intelligent converter system is used to improve power generation performance, PV array in previous case can be reconfigured as in Figure 7.

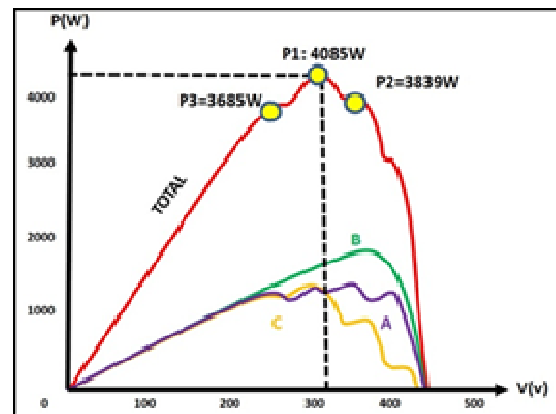

Figure 6. P-V characteristics curve of string A, B, C and total arrays

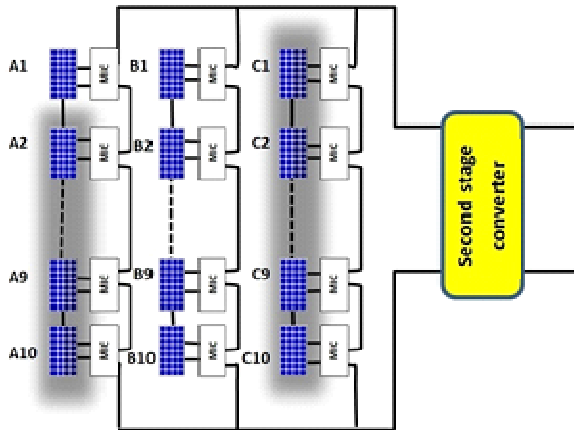

Figure 7. Case study arranged with intelligent structure

The output for single intelligent converter in string A can be represented by one of the four curves shown in Figure 9. according to individual irradiance.

Because of series connection, the output current should be the same for all the ten output converters in string A. Directly stacking the ten output I-V curves along horizontal axis renders the total output I-V curve of string A, as shown in Figure 10.

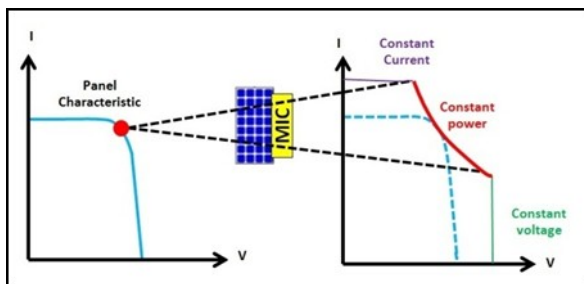

Figure 8. Input & output characteristics of single intelligent converter

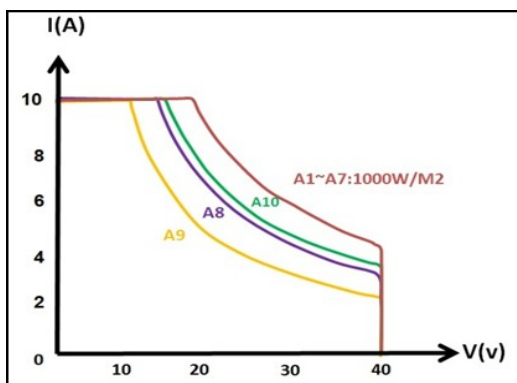

Figure 9. Panels I-V Characteristics of string A

Compared to Figure 5. there is a wide range (k_1 to k_2) which all the panels can generate maximum power. Through the same process, output P-V curves of the whole system can be drawn as in Figure 11. Total available power of system with 14 percent increase is 4672W.

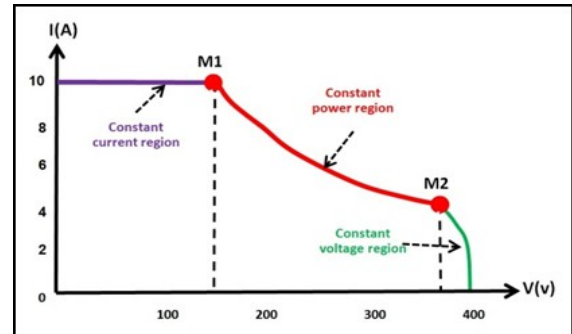

Figure 10. Composite output of string A

Thus, once we go through this process, the benefit of intelligent structure is quite obvious. The essence is that each intelligent converter extends panel maximum power region from one particular point to a wide area. Overlapping of these areas is easy to find even under mismatch conditions. On the power versus voltage curve in Figure 11., a flat area indicates the maximum power points of all panels are tracked by intelligent converter and thus deliver maximum power. Since the constant power range is determinate by voltage and current limit, and changing radiation, then in order to ensure the maximum power in the region, we will need a second converter, which guarantees the performance in MPP region.

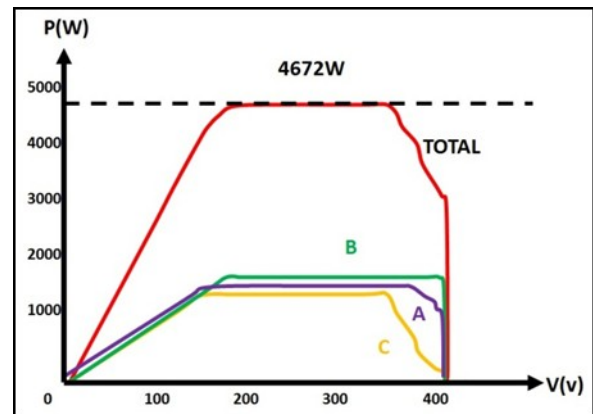

Figure 11. Output P-V of A, B, C and array output P-V

4. MAXIMUM POWER POINT TRACKING

The essential function of the aforementioned PV system, including central and string PV structure, micro-converter and intelligent structure, is Maximum Power Point Tracking (MPPT). The basic concept of

MPPT is based on Perturb and Observe. In order to find the PV array optimal operating point, PV converter continuously monitors the output power of the PV array by measuring voltage and current. If the operating point is not the optimal, it is then regulated to be moved in the direction where more power would be delivered. This operation point movement is achieved by controlling the variables such as voltage and current. Moreover, due to the fact that MPP current of PV array will change significantly with rapidly changing sunlight, current control has bad performance in such conditions. Based on the above reasons, current control is not very preferable.

4. 1. Instability problem in voltage control With choosing voltage as control variable, the problem can be represented in Figure 12.

Because MPPT region has a tiny slope due to system wiring copper loss, MPPT will push the operating point rightward to higher and higher voltage range (A to B). Once it reaches the MPP, another perturbation of voltage then drives operating point drop down the cliff. This step introduces significant power drop ΔP which happens intermittently. This lowers down the equivalent power generation efficiency. The magnitude of the power drop depends on the time constant of the power converter and MPPT sampling period. In the worst case where the MPPT sampling period is much longer than the time constant of the power converter, the output power could drop down to almost zero during this process. Therefore, we can conclude that voltage control is not suitable variable and system to be instable.

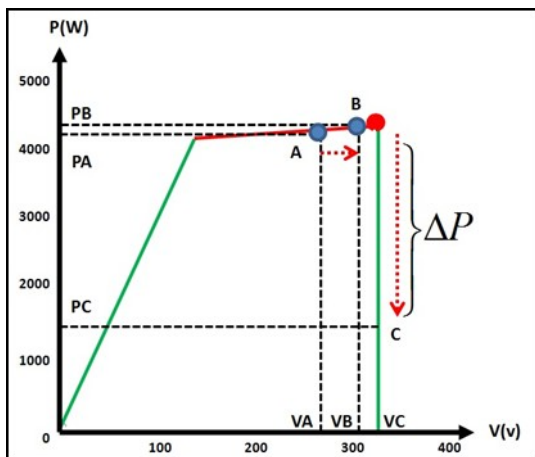

Figure 12. Voltage control instability

4. 2. Conductance control The basic problem is to avoid direct controlling over voltage and current. Then, incremental conductance (Inc. Cond) method is proposed to achieve MPPT via conductance. It means that the conductance is chosen as a control variable rather than voltage and current. During each MPPT period, the conductance should be updated. The process

of conductance MPPT can be represented by Figure 13. This clearly shows that point E is a stable operating point. But, to survey the performance of this MPPT method, we need to find a way for evaluation.

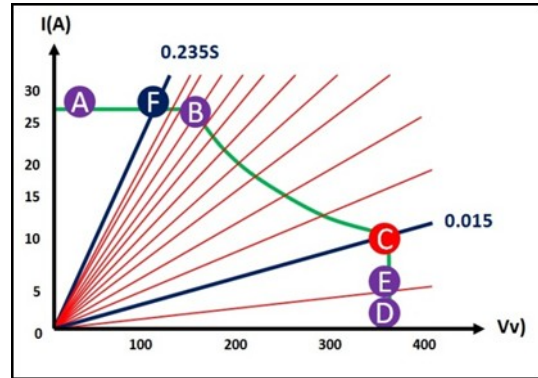

Figure 13. Representation of conductance control MPPT with constant step size

4. 2. 1. Utilization ratio In order to quantify, the utilization ratio, serves as an analytical factor to evaluate MPPT performance. It is defined as (1):

$$K_u = \frac{P_{avg}}{P_m} \tag{1}$$

In (1) P_{avg} is the actual average power, considering the power deviation from maximum power (P_m), due to current ripple.

4. 2. 2. Steady State Performance of Conductance Control MPPT

The process of Conductance can be represented by Figure 14. The group of straight lines is drawn from $G_s=0.015S$ to $G_s=0.235S$ with evenly spaced step size equal to $\Delta G=0.02S$.

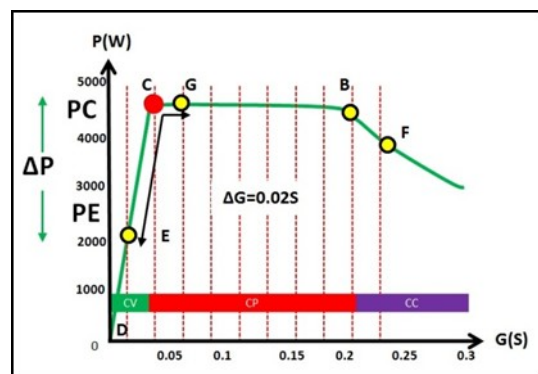

Figure 14. Steady state operation of conductance control MPPT

The true MPP is point C which needs to be tracked. Assuming the initial point is at F with $G_s=0.235S$ and P&O algorithm is used, MPPT firstly perturbs the operating point by decreasing the conductance, which results in operating point to move towards B, because

the power is increasing. Conductance will be further decreased step by step after entering MPPT region. Once it reaches C, another reduction of conductance leads operating point to E which is a stable operating point in voltage limit region. To evaluate the steady state performance of MPPT, the magnitude of the power deviation from C can be regarded as a criterion.

Assuming that the MPPT sampling period is T_{mppt} and the step size is ΔG which is constant. The worst case for the power drop ΔP occurs when the operating point C is exactly at MPP.

The output power values when operating at C and G are both approximately P_m . However, when operating at E, the output power is $P_m - \Delta P$. Thus, the utilization then can be calculated as:

$$P_{avg} = \frac{2P_m T_{mppt} + (P_m - \Delta P) T_{mppt}}{3T_{mppt}} = P_m - \frac{\Delta P}{3} \Rightarrow$$

$$K_u = 1 - \frac{\Delta P}{3P_m} \quad (2)$$

The typical acceptable utilization ratio is 98%. By (2) the maximum powers drop to be 276W.

Because both C and E are located within voltage limit region, maximum conductance step size by solving (3).

$$\Delta G = \frac{\Delta P}{V_L^2} \quad (3)$$

The above calculation result gives us the maximum conductance step size is 0.00212s.

The conductance values at point F and C are 0.235S and 0.035S respectively. Thus time tracking from F to C in terms of T_{mppt} to be $94T_{mppt}$. It means in order to maintain 98% utilization ratio at steady state, the selected step size gives rise to a 94 MPPT sampling periods of tracking time to move from initial point F to point C.

5. PROPOSED RESISTANCE AS CONTROL VARIABLE

In order to overcome the drawbacks of conductance control MPPT, there is another way very similar to solve the MPPT instability problem. The reciprocal of conductance is resistance. By definition, the absolute resistance is the ratio between voltage and current at MPP.

Similar to the conductance approach, the group of straight lines is drawn in Figure 15. from $R_s=4\Omega$ to $R_s=34\Omega$ with evenly spaced step size equal to $\Delta R_s=2\Omega$. As shown in Figure 16., there is no MPPT instability problem; thus, there is no abrupt power drop when perturbing around C and B. For resistance control MPPT, the previous analysis process is still applicable, because it is also a three-point operation in steady state as shown in Figure 16.

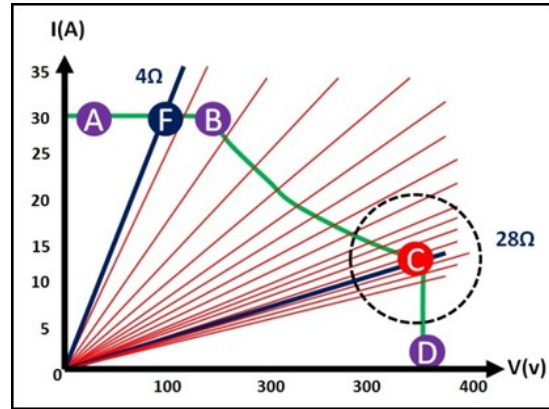

Figure 15. Representation of resistance control MPPT with constant step size

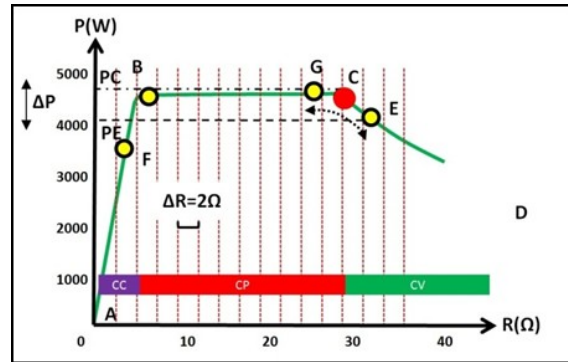

Figure 16. Steady state operation of conductance control MPPT

The worst case for the power drop ΔP occurs when the middle operating point C is exactly at MPP. The output power values when operating at C and G' are both approximately P_m . However, when operating at E', the output power is $P_m - \Delta P$, as before, the utilization ratio can be then calculated by (3). In order to make reasonable comparison between resistance and conductance control variable MPPT, the acceptable utilization ratio is also set to be 98%. Because both C and E are located within voltage limit region, (4) stands the maximum step size of ΔR .

$$\Delta R = \frac{\Delta P * V_L^2}{P_m^2 - P_m \Delta P} \quad (4)$$

In this particular case, the system voltage limit and maximum power are 360V and 4600W, respectively. To limit the power drop to be less than 276W, the maximum step size calculated by (5) is 1.81 Ω . Then, resistance values at point F and C are 4 Ω and 28 Ω , respectively. This means that the tracking time from F' to C in terms of T_{mppt} is 13 T_{mppt} . The selected step size gives rise to only 13 MPPT sampling periods of tracking time to move from initial point F to point C,

which is much faster than the conductance MPPT control.

PV Panel" *IX Symposium Industrial Electronics INDEL 2012, Banja Luka*, (2012), 189-193.

6. CONCLUSION

A drawback of conventional PV structures is low power generation efficiency when mismatch happens. To solve this problem the intelligent structure is presented. For evaluation, a case study has been presented which demonstrates with intelligent PV system, due to distributed MPPT for each individual panel, the power generation efficiency increased about 14 percent.

Then, selection of suitable MPPT methods for intelligent converter is presented. The MPPT instability problem is observed when conventional voltage control is used. To overcome the drawback conductance and resistance control are proposed and analyzed. Comparison of these two methods reveals that although they are both doable, the resistance control is more desirable than conductance control. From the standpoint of steady state performance, conductance and resistance control MPPT is proposed and compared in terms of steady state performance and tracking speed. Although both of them can solve the MPPT instability problem, the resistance control MPPT is more suitable and advantageous because of its higher utilization ratio in steady state and faster tracking speed.

REFERENCES

1. Hiren, P., Member, S. and Vivek, A., "MATLAB-Based Modeling to Study the Effects of Partial Shading on PV Array Characteristics", *IEEE Transactions on Energy Conversion*, Vol. 23, (2008).
2. Román, E., Martínez, V., Jimeno, J.C., Alonso, R., Ibañez, P. and Elorduizapatarietxe, S., "Experimental results of controlled PV module for building integrated PV systems", *Solar Energy*, Vol. 82, (2008), 471-480.
3. Huang, Y., Peng, F.Z., Wang, J. and Yoo, D.-W., "Survey of the power conditioning system for pv power generation", in the 37th IEEE Power Electronics Specialists Conference, PESC'06, June 18-22, (2006), Jeju, 1-6.
4. Bratcu, A.I., Munteanu, I., Bacha, S., Picault, D. and Raison, B., "Cascaded DC-DC converter photovoltaic systems: power optimization issues", *IEEE Transactionson Industry Electron*, Vol. 58, (2011), 403-411.
5. Linares, L., Erickson, R.W., MacAlpine, S., Brandemuehl, M., "Improved energy capture in series string photovoltaics via smart distributed power electronics", Applied Power Electronics Conference and Exposition, (2009), Twenty-Fourth Annual IEEE.
6. Kjaer, S.B., Pedersen, J.K., Member, S. and Blaabjerg, F., "A review of single-phase grid connected inverters for photovoltaic modules", *IEEE Transactionson Industry Applications*, Vol. 41, (2005), 1292-1306.
7. Barth, C.B. and Pilawa-Podgurski, R.C.N., "Dithering digital ripple correlation control with digitally-assisted windowed sensing for solar photovoltaic MPPT", *Applied Power Electronics Conference and Exposition (APEC)*, (2014), 1738 – 1746
8. Forcan, M., Tuševljak, J., Lubura, S. and Šoja, M., "Analyzing and Modeling the Power Optimizer for Boosting Efficiency of